

# LM4680 Boomer® Audio Power Amplifier Series

## 10W High-Efficiency Mono BTL Audio Power Amplifier

### General Description

The LM4680 is a high efficiency switching audio power amplifier primarily designed for demanding applications in flat panel monitors and TV's. It is capable of delivering 10W to an 8Ω mono BTL load with less than 10% distortion (THD+N) when powered from a 14V<sub>DC</sub> power supply.

Boomer audio power amplifiers were designed specifically to provide high quality output power with a minimal amount of external components. The LM4680 features a micro-power, active-low shutdown mode, an internal thermal shutdown protection mechanism, output fault detect, and short circuit protection.

The LM4680 contains advanced transient ("pop and click") suppression circuitry that eliminates noises that would otherwise occur during turn-on and turn-off transitions.

### Key Specifications

■ Power Output BTL ( $V_{DD} = 14V$ , $f_{IN} = 1kHz$ , THD+N = 10%, $R_L = 8\Omega$ )	10W (typ)
■ Quiescent Power Supply Current	25mA (typ)
■ Efficiency ( $V_{DD} = 12V$ , $f_{IN} = 1kHz$ , $R_L = 8\Omega$ , $P_{OUT} = 6W$ )	81% (typ)
■ Shutdown Current	0.1mA (typ)
■ Fixed Gain	30dB (typ)

### Features

- Soft-start circuitry eliminates noise during turn-on transition
- Low current shutdown mode
- Low quiescent current
- 6W BTL output,  $R_L = 8\Omega$ , THD+N = 1%
- Short circuit protection
- Fixed, internally set gain of 30dB
- Internal clamp diodes protect amplifier outputs

### Applications

- Flat Panel Monitors
- Flat Panel TVs
- Computer Sound Cards

### Connection Diagram

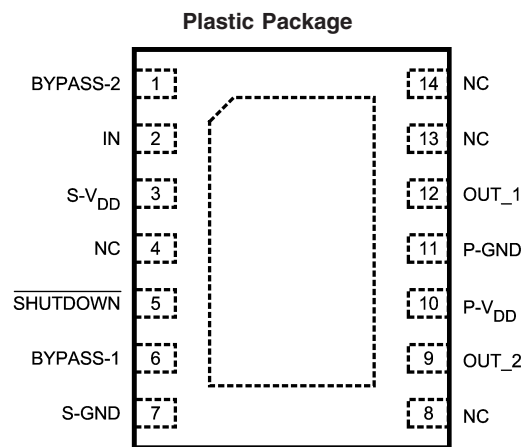

20095802

Top View  
Order Number LM4680SD  
See NS Package Number SRC14A

## Typical Application

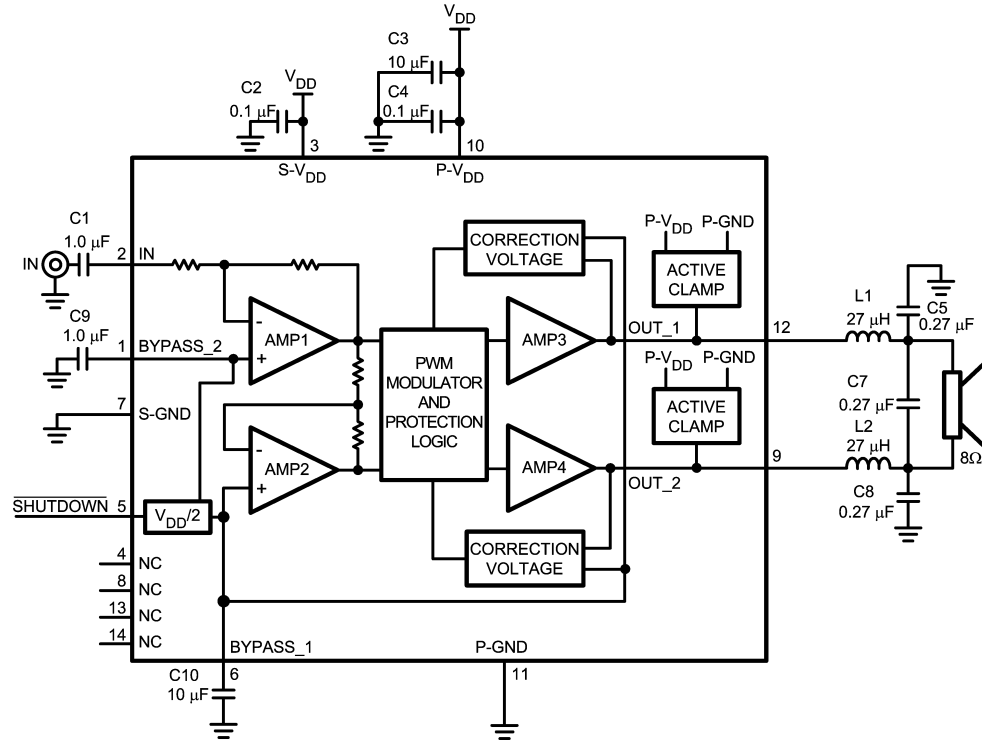

20095801

FIGURE 1. Typical Audio Amplifier Application Circuit

## LM4680SD Demo Board Bill of Material

Item	Part Description	Package Size	Qty	Ref Designator	Remark	Supplier
1	LM4680SD Audio Amplifier	LLP14	1	U1		
2	Cer Cap 0.1µF 16V 10%	0805	1	C4	PCC1812CT-ND	Digi - Key
3	Cer Cap 0.27µF 16V 10%	0805	3	C5, C7, C8	PCC1916CT-ND	Digi - Key
4	Cer Cap 1.0µF 25V 10%	0805	2	C1 - C2	PCC2319CT-ND	Digi - Key
5	Tant Cap 1.0µF 16V 10%	Size = A (3216)	2	C9	399-1583-2-ND	Digi - Key
6	Tant Cap 10.0µF 16V 10%	Size = A (3216)	2	C10	478-1655-2-ND	Digi - Key
7	Tant Cap 10.0µF 16V 10%	Size = A (3216)	1	C3	478-1655-2-ND	Digi - Key
8	Inductor 4922 Series 27µH SMT		2	L1, L2	DN2218CT-ND	Digi - Key

**Absolute Maximum Ratings** (Notes 1, 2)

If Military/Aerospace specified devices are required, please contact the National Semiconductor Sales Office/Distributors for availability and specifications.

Supply Voltage	16V
Storage Temperature	-65°C to +150°C
Input Voltage	-0.3V to $V_{DD} + 0.3V$
Power Dissipation (Note 3)	Internally limited
ESD Susceptibility (Note 4)	2000V
ESD Susceptibility (Note 5)	200V

Junction Temperature	150°C
Thermal Resistance	
$\theta_{JC}$ (LD)	2°C/W
$\theta_{JA}$ (LD)	40°C/W

**Operating Ratings**

Temperature Range	$-40^{\circ}\text{C} \leq T_A \leq 85^{\circ}\text{C}$
Supply Voltage (Note 10)	$9.0V \leq V_{DD} \leq 14V$

**Electrical Characteristics for the LM4680** (Note 1)

The following specifications apply for the circuit shown in Figure 1 operating with  $V_{DD} = 12V$ ,  $R_L = 8\Omega$ , and  $f_{IN} = 1\text{kHz}$ , unless otherwise specified. Limits apply for  $T_A = 25^{\circ}\text{C}$ .

Symbol	Parameter	Conditions	LM4680		Units (Limits)
			Typical (Note 6)	Limit (Notes 7, 8)	
$I_{DD}$	Quiescent Power Supply Current	$V_{IN} = 0V$ , $I_O = 0A$ , $R_L = 8\Omega$	28	52	mA
$I_{SD}$	Shutdown Current	$V_{SHUTDOWN} = \text{GND}$ (Note 9)	0.1		mA
$A_V$	Amplifier Gain	BTL output voltage with respect to input voltage	30		dB
$P_O$	Output Power	THD+N = 1% (max) THD+N = 10%, $V_{DD} = 14V$	6 10	5	W
THD+N	Total Harmonic Distortion + Noise	$P_{OUT} = 1W_{RMS}$	0.2		%
$f_{BW}$	Frequency Response Bandwidth	$P_{OUT} = 6W$ , post filter, -3dB relative to 1kHz	20 20000		Hz Hz
$\eta$	Efficiency	$P_{OUT} = 6W$	81		%
$\epsilon_N$	Output Noise	A-Weighted Filter, $V_{IN} = 0V$ , Input Referred	10		$\mu\text{V}$
SNR	Signal-to-Noise Ratio	A-Weighted Filter, $P_{OUT} = 6W$ Input Referred	116		dB
PSRR	Power Supply Rejection Ratio	$V_{RIPPLE} = 200mV_{p-p}$ , $C_{BYPASS\_1} = 10\mu\text{F}$ , Input Referred $f = 50\text{Hz}$ $f = 60\text{Hz}$ $f = 100\text{Hz}$ $f = 120\text{Hz}$ $f = 1\text{kHz}$	99 101 102 102 104		dB
$t_{WU}$	Wake-Up time	$C_{BYPASS} = 10\mu\text{F}$	600		ms
$T_{SD}$	Thermal Shutdown Temperature		170		$^{\circ}\text{C}$ $^{\circ}\text{C}$
$V_{SDIH}$	Shutdown Voltage Input High			4	V (min)
$V_{SDIL}$	Shutdown Voltage Input Low			1.5	V (max)

**Note 1:** All voltages are measured with respect to the GND pin unless otherwise specified.

**Note 2:** Absolute Maximum Ratings indicate limits beyond which damage to the device may occur. Operating Ratings indicate conditions for which the device is functional, but do not guarantee specific performance limits. Electrical Characteristics state DC and AC electrical specifications under particular test conditions which guarantee specific performance limits. This assumes that the device is within the Operating Ratings. Specifications are not guaranteed for parameters where no limit is given, however, the typical value is a good indication of device performance.

**Note 3:** The maximum power dissipation must be derated at elevated temperatures and is dictated by  $T_{JMAX}$ ,  $\theta_{JA}$ , and the ambient temperature  $T_A$ . The maximum allowable power dissipation is  $P_{DMAX} = (T_{JMAX} - T_A)/\theta_{JA}$  or the number given in Absolute Maximum Ratings, whichever is lower. For the LM4680 typical application (shown in Figure 1) with  $V_{DD} = 12V$ ,  $R_L = 8\Omega$  stereo operation, the total power dissipation is 900mW.  $\theta_{JA} = 40^\circ C/W$

**Note 4:** Human body model, 100pF discharged through a 1.5k $\Omega$  resistor.

**Note 5:** Machine model, 220pF – 240pF discharged through all pins.

**Note 6:** Typicals are measured at 25°C and represent the parametric norm.

**Note 7:** Limits are guaranteed to National's AOQL (Average Outgoing Quality Level).

**Note 8:** Datasheets min/max specification limits are guaranteed by design, test, or statistical analysis.

**Note 9:** Shutdown current is measured in a normal room environment. The SHUTDOWN pin should be driven as close as possible to GND for minimum shutdown current.

**Note 10:** Please refer to "Under Voltage Protection" on page 8 under "General Features."

## Typical Performance Characteristics

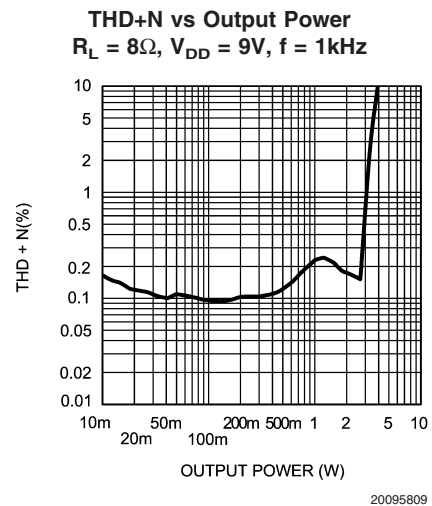
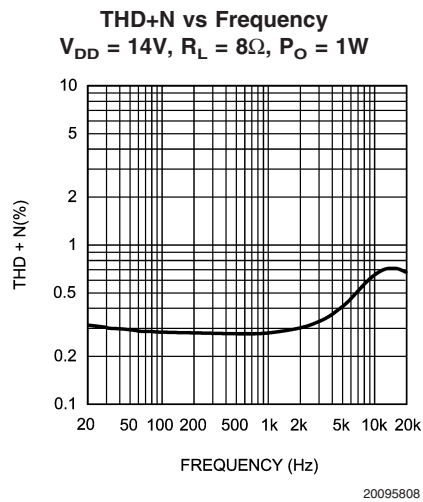
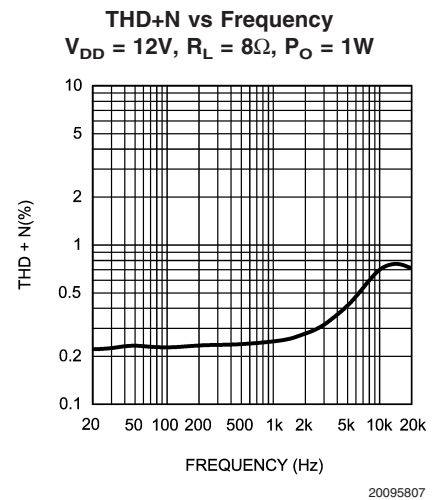
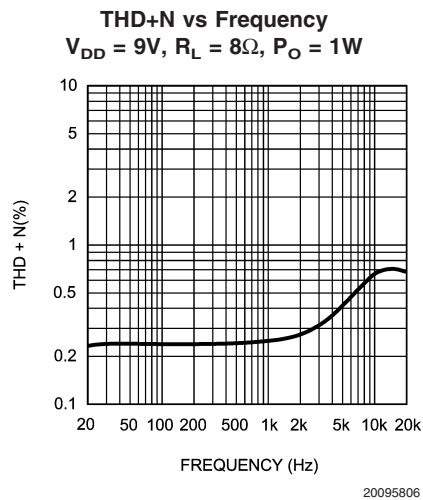

Typical Performance Characteristics (Continued)

**THD+N vs Output Power**  
 $R_L = 8\Omega, V_{DD} = 12V, f = 1kHz$

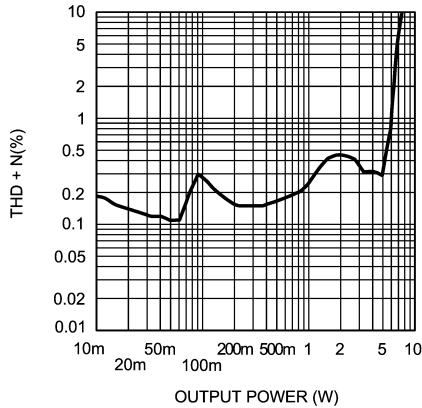

20095810

**THD+N vs Output Power**  
 $R_L = 8\Omega, V_{DD} = 14V, f = 1kHz$

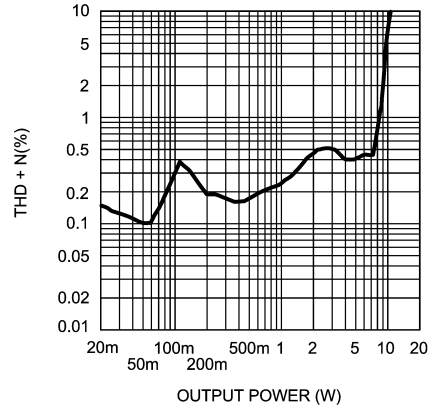

20095811

**Amplifier Output Power vs Power Supply Voltage**  
 $R_L = 8\Omega, f = 1kHz$

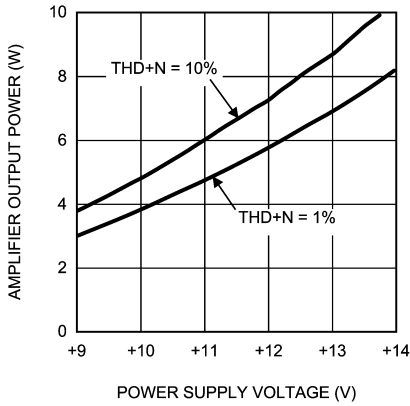

20095812

**Amplifier Output Magnitude vs Frequency**  
 $R_L = 8\Omega, V_{DD} = 12V$

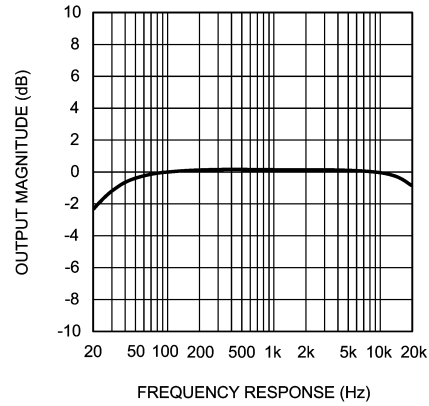

20095813

**Power Rejection Ratio vs Frequency**  
 $V_{DD} = 9V, R_L = 8\Omega, \text{Input Referred}$

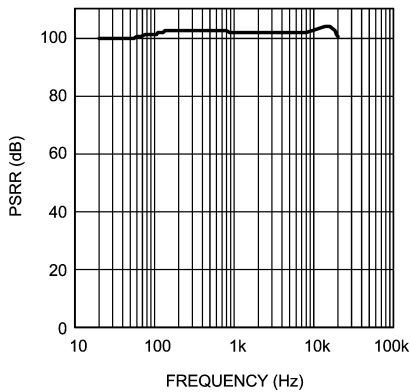

20095825

**Power Rejection Ratio vs Frequency**  
 $V_{DD} = 12V, R_L = 8\Omega, \text{Input Referred}$

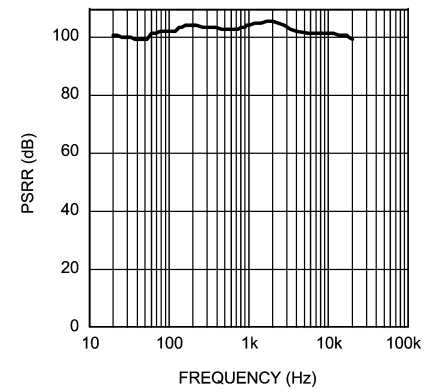

20095826

# Typical Performance Characteristics (Continued)

**Power Rejection Ratio vs Frequency**  
 $V_{DD} = 14V, R_L = 8\Omega$ , Input Referred

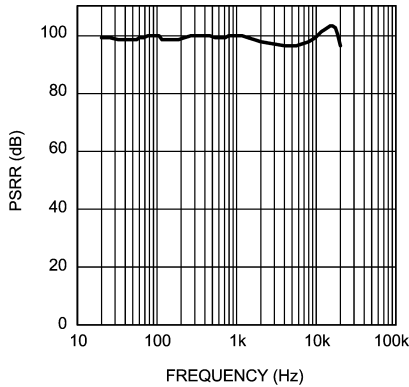

20095827

**Amplifier Power Dissipation vs Amplifier Load Dissipation**  
 $V_{DD} = 14V, R_L = 8\Omega, f = 1kHz$

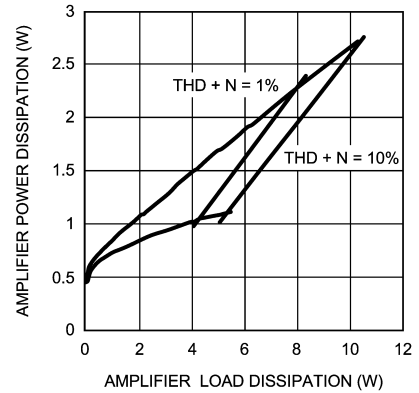

20095817

**Amplifier Power Dissipation vs Load Power Dissipation**  
 $V_{DD} = 12V, R_L = 8\Omega, f = 1kHz$

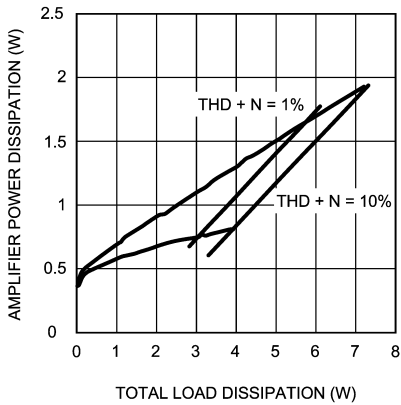

20095818

**Amplifier Power Dissipation vs Total Load Power Dissipation**  
 $V_{DD} = 9V, R_L = 8\Omega, f = 1kHz$

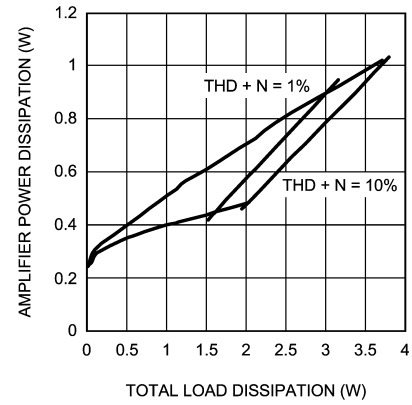

20095819

**Output Power vs Load Resistance**  
 $V_{DD} = 14V, f = 1kHz$

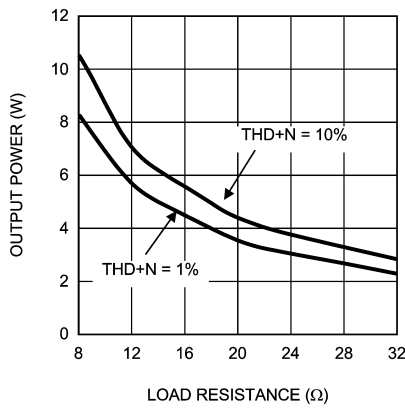

20095820

**Output Power vs Load Resistance**  
 $V_{DD} = 12V, f = 1kHz$

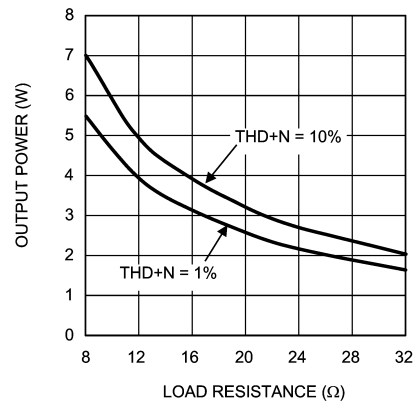

20095821

Typical Performance Characteristics (Continued)

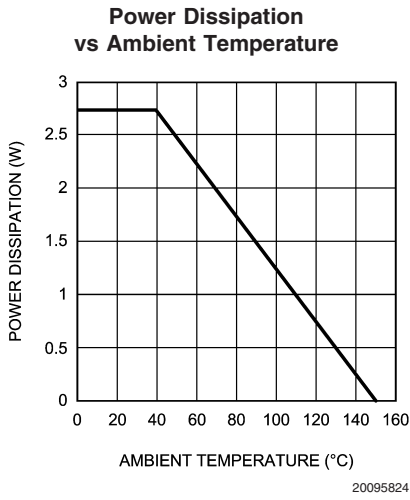
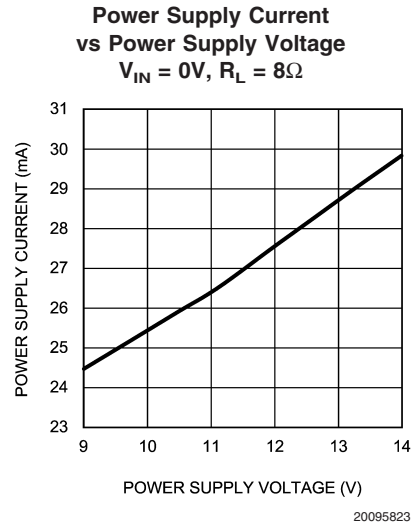
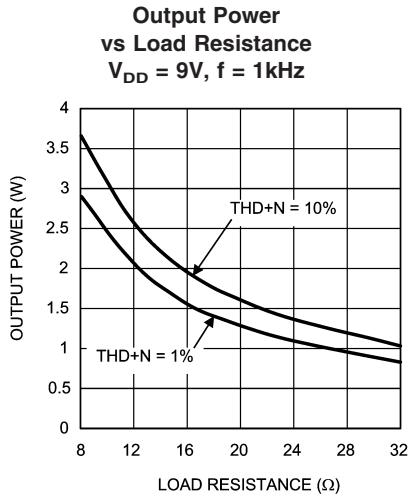

## General Features

### SYSTEM FUNCTIONAL INFORMATION

#### Modulation Technique

Unlike typical Class D amplifiers that use single-ended comparators to generate a pulse-width modulated switching waveform and RC timing circuits to set the switching frequency, the LM4680 uses a balanced differential floating modulator. Oscillation is a result of injecting complimentary currents onto the respective plates of a floating, on-die capacitor. The value of the floating capacitor and value of the components in the modulator's feedback network and sets the nominal switching frequency at 450kHz. Modulation results from imbalances in the injected currents. The amount of current imbalance is directly proportional to the applied input signal's magnitude and frequency.

Using a balanced, floating modulator produces a Class D amplifier that is immune to common mode noise sources such as substrate noise. This noise occurs because of the high frequency, high current switching in the amplifier's output stage. The LM4680 is immune to this type of noise because the modulator, the components that set its switching frequency, and even the load all float with respect to ground.

The balanced modulator's pulse width modulated output drives the gates of the LM4680's H-bridge configured output power MOSFETs. The pulse-train present at the power MOSFETs' output is applied to an LC low pass filter that removes the 450kHz energy component. The filter's output signal, which is applied to the driven load, is an amplified replica of the audio input signal.

#### Shutdown Function

The LM4680's active-low shutdown function allows the user to place the amplifier in a shutdown mode while the system power supply remains active. Activating shutdown deactivates the output switching waveform and minimizes the quiescent current. Applying logic 0 (GND) to pin 8 enables the shutdown function. Applying logic 1 ( $4V \leq V_{\text{LOGIC}} \leq V_{\text{DD}}$ ) to pin 8 disables the shutdown function and restores full amplifier operation.

#### Under Voltage Protection

The under voltage protection disables the output driver section of the LM4680 while the supply voltage is below 8V. This condition may occur as power is first applied or during low line conditions, changes in load resistance, or when power supply sag occurs. The under voltage protection ensures that all of the LM4680's power MOSFETs are off. This action eliminates shoot-through current and minimizes output transients during turn-on and turn-off. The under voltage protection gives the digital logic time to stabilize into known states, further minimizing turn output transients.

#### Turn-On Time

The LM4680 has an internal timer that determines the amplifier's turn-on time. After power is first applied or the part returns from shutdown, the nominal turn-on time is 600ms. This delay allows all externally applied capacitors to charge to a final value of  $V_{\text{DD}}/2$ . Further, during turn-on, the outputs are muted. This minimizes output transients that may occur while the part settles into its quiescent operating mode.

#### Output Stage Current Limit and Fault Detection Protection

The output stage MOSFETs are protected against output conditions that could otherwise compromise their operational status. The first stage of protection is output current limiting. When conditions that require high currents to drive a load, the LM4680's current limit circuitry clamps the output current at a nominal value of 2.5A. The output waveform is present, but may be clipped or its amplitude reduced. The same 2.5A nominal current limit also occurs if the amplifier outputs are shorted together or either output is shorted to  $V_{\text{DD}}$  or GND.

The second stage of protection is an onboard fault detection circuit that continuously monitors the signal on each output MOSFET's gate and compares it against the respective drain voltage. When a condition is detected that violates a MOSFET's Safe Operating Area (SOA) and the drive signal is disconnected from the output MOSFETs' gates. The fault detect circuit maintains this protective condition for approximately 600ms, at which time the drive signal is reconnected. If the fault condition is no longer present, normal operation resumes. If the fault condition remains, however, the drive signal is again disconnected.

#### Thermal Protection

The LM4680 has thermal shutdown circuitry that monitors the die temperature. Once the LM4680 die temperature reaches 170°C, the LM4680 disables the output switching waveform and remains disabled until the die temperature falls below 140°C (typ).

#### Over-Modulation Protection

The LM4680's over-modulation protection is a result of the preamplifier's (AMP1 and AMP2, Figure 1) inability to produce signal magnitudes that equal the power supply voltages. Since the preamplifier's output magnitude will always be less than the supply voltage, the duty cycle of the amplifier's switching output will never reach zero. Peak modulation is limited to a nominal 95%.

## Application Hints

### SUPPLY BYPASSING

Correct power supply bypassing has two important goals. The first is to reduce noise on the power supply lines and minimize deleterious effects that the noise may cause to the amplifier's operation. The second is to help stabilize an unregulated power supply and to improve the supply's transient response under heavy current demands. These two goals require different capacitor value ranges. Therefore, various types and values are recommended for supply bypassing. For noise de-coupling, generally small ceramic capacitors (0.01 $\mu\text{F}$  to 0.1 $\mu\text{F}$ ) are recommended. Larger value (1 $\mu\text{F}$  to 10 $\mu\text{F}$ ) tantalum capacitors are needed for the transient current demands. These two capacitors in parallel will do an adequate job of removing most noise from the supply rails and providing the necessary transient current. These capacitors should be placed as close as possible to each IC's supply pin(s) using leads as short as possible.

The LM4680 has two  $V_{\text{DD}}$  pins: a power  $V_{\text{DD}}$  ( $PV_{\text{DD}}$ ) and a signal  $V_{\text{DD}}$  ( $SV_{\text{DD}}$ ). The parallel combination of the low value ceramic (0.1 $\mu\text{F}$ ) and high value tantalum (10 $\mu\text{F}$ ) should be used to bypass the  $PV_{\text{DD}}$  pin. A small value (0.1 $\mu\text{F}$ ) ceramic or tantalum can be used to bypass the  $SV_{\text{DD}}$  pin.



## Application Hints (Continued)

### OUTPUT STAGE FILTERING

The LM4680 requires a low pass filter connected between the amplifier's bridge output and the load. Figure 1 shows the recommended LC filter. A minimum value of  $27\mu\text{H}$  is recommended. As shown in Figure 1, using the values of the components connected between the amplifier BTL outputs and the load achieves a 2nd-order lowpass filter response with a -3dB cutoff frequency of 25kHz.

### THD+N MEASUREMENTS AND OUT OF AUDIO BAND NOISE

THD+N (Total Harmonic Distortion plus Noise) is a very important parameter by which all audio amplifiers are measured. Often it is shown as a graph where either the output power or frequency is changed over the operating range. A very important variable in the measurement of THD+N is the bandwidth-limiting filter at the input of the test equipment. Class D amplifiers, by design, switch their output power devices at a much higher frequency than the accepted audio range (20Hz - 20kHz). Alternately switching the output voltage between  $V_{DD}$  and GND allows the LM4680 to operate at much higher efficiency than that achieved by traditional Class AB amplifiers. Switching the outputs at high frequency also increases the out-of-band noise. Under normal circum-

stances the output lowpass filter significantly reduces this out-of-band noise. If the low pass filter is not optimized for a given switching frequency, there can be significant increase in out-of-band noise. THD+N measurements can be significantly affected by out-of-band noise, resulting in a higher than expected THD+N measurement. To achieve a more accurate measurement of THD, the test equipment's input bandwidth of the must be limited. Some common upper filter points are 22kHz, 30kHz, and 80kHz. The input filter limits the noise component of the THD+N measurement to a smaller bandwidth resulting in a more real-world THD+N value.

### Recommended Printed Circuit Board Layout

Figures 2 through 4 show the recommended two-layer PC board layout that is optimized for the 14-pin SD-packaged LM4680 and associated external components. This circuit is designed for use with an external 12V supply and 8W speakers (or load resistors). This circuit board is easy to use. Apply 12V and ground to the board's  $V_{DD}$  and GND terminals, respectively. Connect speakers (or load resistors) between the board's -OUT and +OUT terminals. Apply the input signal to the input pin labeled -IN.

# Demonstration Board Layout

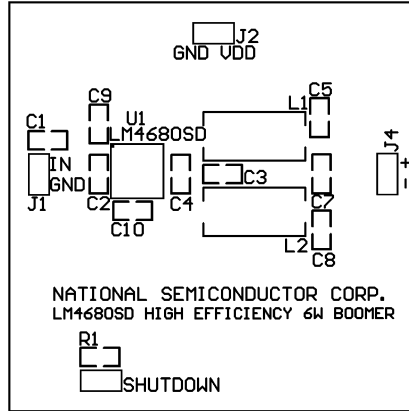

20095803

**FIGURE 2. Recommended SD PCB Layout  
Top Silkscreen**

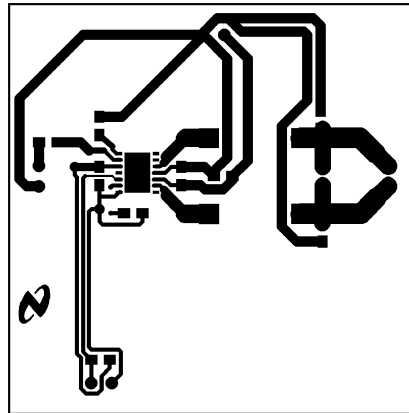

20095804

**FIGURE 3. Recommended SD PCB Layout  
Top Layer**

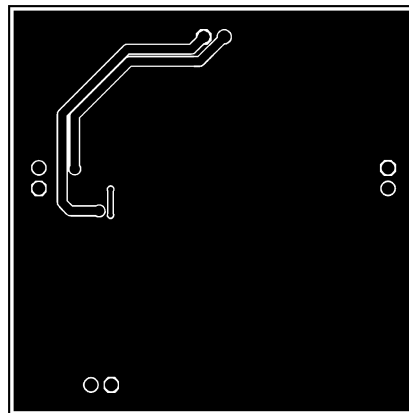

20095805

**FIGURE 4. Recommended SD PCB Layout  
Bottom Layer**

## Physical Dimensions inches (millimeters)

unless otherwise noted

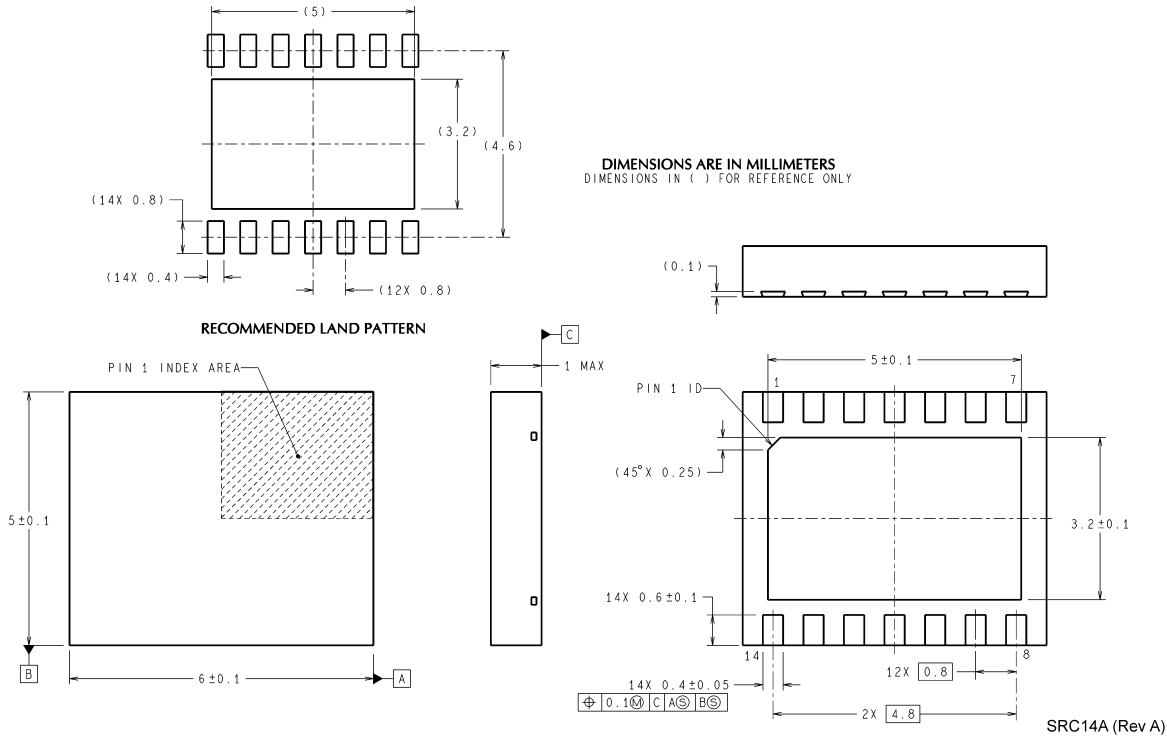

National does not assume any responsibility for use of any circuitry described, no circuit patent licenses are implied and National reserves the right at any time without notice to change said circuitry and specifications.

For the most current product information visit us at [www.national.com](http://www.national.com).

### LIFE SUPPORT POLICY

NATIONAL'S PRODUCTS ARE NOT AUTHORIZED FOR USE AS CRITICAL COMPONENTS IN LIFE SUPPORT DEVICES OR SYSTEMS WITHOUT THE EXPRESS WRITTEN APPROVAL OF THE PRESIDENT AND GENERAL COUNSEL OF NATIONAL SEMICONDUCTOR CORPORATION. As used herein:

1. Life support devices or systems are devices or systems which, (a) are intended for surgical implant into the body, or (b) support or sustain life, and whose failure to perform when properly used in accordance with instructions for use provided in the labeling, can be reasonably expected to result in a significant injury to the user.
2. A critical component is any component of a life support device or system whose failure to perform can be reasonably expected to cause the failure of the life support device or system, or to affect its safety or effectiveness.

### BANNED SUBSTANCE COMPLIANCE

National Semiconductor certifies that the products and packing materials meet the provisions of the Customer Products Stewardship Specification (CSP-9-111C2) and the Banned Substances and Materials of Interest Specification (CSP-9-111S2) and contain no "Banned Substances" as defined in CSP-9-111S2.



**National Semiconductor**  
**Americas Customer Support Center**  
Email: [new.feedback@nsc.com](mailto:new.feedback@nsc.com)  
Tel: 1-800-272-9959

**National Semiconductor**  
**Europe Customer Support Center**  
Fax: +49 (0) 180-530 85 86  
Email: [europe.support@nsc.com](mailto:europe.support@nsc.com)  
Deutsch Tel: +49 (0) 69 9508 6208  
English Tel: +44 (0) 870 24 0 2171  
Français Tel: +33 (0) 1 41 91 8790

**National Semiconductor**  
**Asia Pacific Customer Support Center**  
Email: [ap.support@nsc.com](mailto:ap.support@nsc.com)

**National Semiconductor**  
**Japan Customer Support Center**  
Fax: 81-3-5639-7507  
Email: [jpn.feedback@nsc.com](mailto:jpn.feedback@nsc.com)  
Tel: 81-3-5639-7560